

HIBLOW®

Air Pump

Instruction Manual

XP Series



 TECHNO TAKATSUKI CO.,LTD.



Table of contents

1	Handling instructions	
1•1	Prior to Use	2
1•2	To Use Safely	2
1•3	Storage and carry	3
1•4	Upon installation	3
1.	Installation site cautions	4
2.	Electrical work cautions	5
3.	For Permanently Connected Product	5
4.	Installation work cautions	5
5.	Plumbing work cautions	6
6.	Preliminary cautions	7
2	Daily maintenance	8
3	After-service care	
3•1	Request to repair	9
3•2	Repair Parts	10

Clipping Date

Environment and Quality ISO



ISO-14001 of the International Organization for Standardization is pursuing organizations, including business enterprises, to voluntarily sets and determine goals for improving the environment, such as contamination prevention, and to achieve these goals organizationally. Furthermore, it calls for organizations to establish a structure to continuously carry out improvements and operate by observing regulations in accordance with regulations relating to the environment. This ISO-14001 is also called the Environmental Passport of International Standards. Meanwhile, the ISO-9000 series is quality control and the guarantee established by ISO in 1987. It is the International Standard of requirements for the quality guarantee system, not for the product itself. There are three quality guarantee models in ISO (ISO-9001, 9002 and 9003): ISO is the strictest standard to obtain as its quality system elements are consistent from planning control to after-service care. Before a product can obtain this standard, there is a three-audit check system consisting of an internal audit, customer audit and a third-party audit, and even after obtaining this standard, regular checks are performed. And furthermore, quality policy and goal announced by top management shall be put in writing, be penetrated the whole organization, become effective and be maintained, In short, the acquisition of ISO-14001 and ISO-9001 is the utmost proof of a trustworthy organization in the past, present and future.

Product Liability Law TECHNO TAKATSUKI

Product Liability Law was adopted in July 1995. Previously, it become difficult for general customers to evaluate the quality of a product due to rapid changes in hi tech, it used to be a great disadvantage to the customer is lawsuit against faulty products. Nowadays, as it is easier to be compensated for loss by proving defects of a product, manufacturers need to pay more attention to quality than ever. Assessing PL Law and carried out various measures, then obtained ISO-9001 in December 1995 and ISO-14001 in November 2000. We are further aiming to enhance quality control and protection of the global environment, therefore, we appreciate your continuing support.

1 Handling Instructions

Regarding indicated warnings

 Warning	Ignoring warnings may cause personal death or serious injury.
 Caution	Ignoring cautions may cause personal casualty and property damage.

1.1 Prior to Use

 **Caution**

This pump is exclusively for pneumatic transportation use.

- As the inhaled fluid passes through the current carrier, inhaling flammable gas or liquid may cause ignition, electrocution or short-circuit accidents.

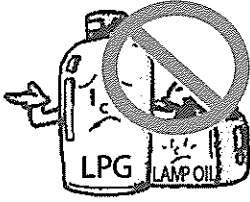

Power source of this pump refer to the rating label.

- Using other than the designated power source may cause electrocution or short-circuit accidents.

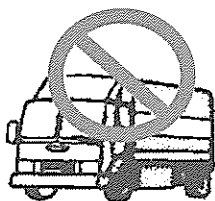

- As this pump is not manufactured to be vehicle-equipped, do not install in cars or other vehicles.
- If the problem of stoppage of airflow occurs, such as for fish culture, be sure to have an extra pump.
 - Please be sure to also check the extra pump once every two months to make sure it is always working properly.

1.2 To Use Safely

 **Caution**

Do not use of the pump by young children or the infirm or valetudinarian persons without supervision.

1·3 Storage and Carry

⚠ Caution

- When carrying the machine body, the body should be held with both hands.
 - Do not carry with the holding filter cover. It may cause the cover to fall off and the machine will fall out.
 - Do not carry by holding the electric cord. It may cause heating or ignition due to disconnection at the center core.
 - Avoid burn injuries by wearing gloves: the temperature of the pump increases while operating.

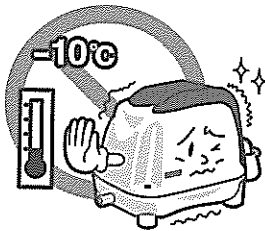
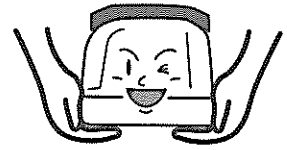

- Store the pump in a temperature area of -10 to 50 degrees Celsius. Temperatures outside of this range may cause of natural deterioration of rubber parts (diaphragm etc.) inside the pump.

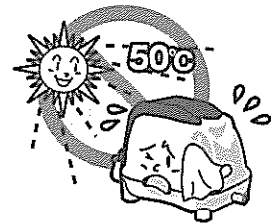

1·4 Upon Installation

⚠ Warning

- Request distributor or professional to install the machine including electrical work and plumbing.
 - Air leakage, electrocution and fire may result if not perfectly installed.
- This appliance can be used by children aged from 8 years and above and persons with reduced physical, sensory or mental capabilities or lack of experience and knowledge if they have been given supervision or instruction concerning use of the appliance in a safe way and understand the hazards involved.
 - Children shall not play with the appliance.
 - Cleaning and user maintenance shall not be made by children without supervision.

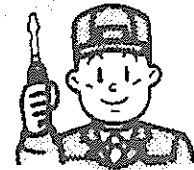

1. Installation site cautions

⚠ Caution

- Install the pump where it is free from exposure to rainwater and snowfall.
- Exposure to water may cause electrical leakage and electrocution as water leaks into the current carrier.

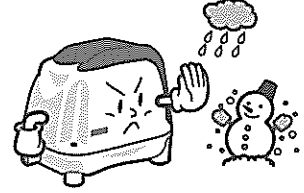

⚠ Caution

- Install the pump above the water level.
Refer to the drawing on page 7.
- Installing the pump lower than the water level will cause the water will flow backward due to the siphon effect when the pump stops. Back-flow may cause electrical leakage, electrocution and short-circuit accidents as the current carrier may be exposed to the water.

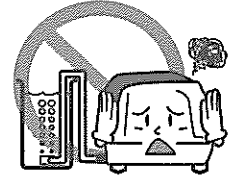

- Do not install the pump where it is potentially flammable gas leaking.
- Leaking flammable gas remnants may cause ignition.



- Install the pump away from where quiet is preferred, such as bedrooms and meeting rooms.
- Machine noise may continue into the night.

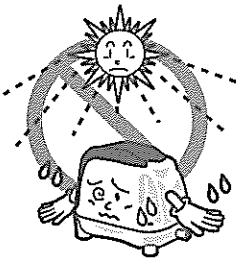
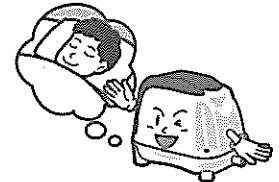

- Install the pump where it is airy.
- A consistently high temperature of the pump's body may shorten the life duration of the diaphragm.

- Avoid dusty and dirty places where it is humid and drafty.

- The life duration of the diaphragm may decrease as the clogging of the acceleration filters causes decrease in air volume and an extreme rise in temperature of the pump.

- Install the pump where it is easy to maintain.

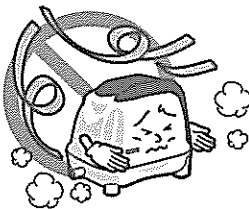

2. Electrical work cautions

⚠ Caution

- Make sure to install the electrical leakage breaker not exceeding 30mA of rated sense current for power source wiring.
- Lack of electrical leakage breaker may cause electrocution.

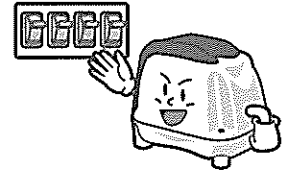

⚠ Caution

- Make sure to use a watertight plug when the pump is installed outdoors.
- Rainwater that falls directly on energized parts may cause electrical leakage and/or electrocution.

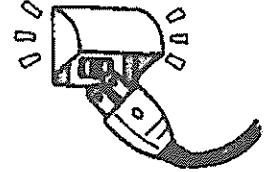

3. For Permanently Connected Product

⚠ Caution

Wiring Diagram

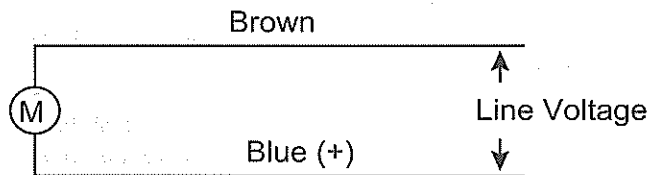

4. Installation work cautions

⚠ Caution

- If there is a possibility that the pump will be exposed to the volume of water, set up a water guard roof or fence.
- If the pump inhales water all the way to current carrier, it may cause electrical leakage, electrocution and/or short-circuit accidents.
- Water will not go inside the pump in the case of a normal amount of rainfall.

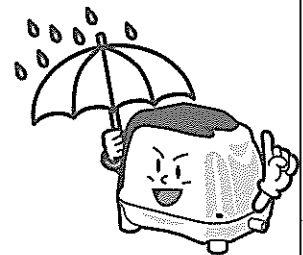

- Mount the pump on a solo-use pedestal. The pedestal should be concrete and be able to lift the mounting 10 cm and above from the basement of the building.
- Installing the pump on a concrete block or shelf may cause the operating noise to be amplified.

- Using a lever to get it horizontal, install the pump after the concrete has completely dried.
 - Installing the pump before the concrete has completely dried will cause the pump to sink into the concrete.
 - Not installing the pump in a horizontal position may shorten the life duration of the parts, as the rubber parts are unreasonably pressed.
- If a waterproofing or noise-insulation fence is being set up, install the ventilator to avoid the temperature rising over 40 degrees (Celsius) inside the fence. Please contact Customer Support for more details.

5.Plumbing work cautions

⚠ Caution

- Do not connect to piping the equipment which increases air pressure, or its kind of thing.

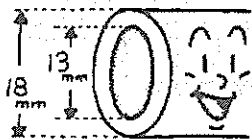

- For pneumatic piping, use a rigid PVC water pipe (internal diameter 13 mm, external diameter 18 mm).

- Make the pneumatic pipe as short as possible and minimize the curve.

- It is as a guide of pneumatic piping length 5 meters. In case of longer than it, take counsel with us.

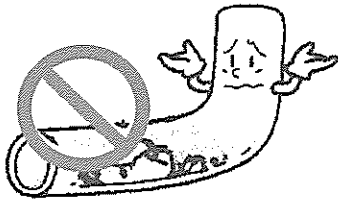

- Make sure no soil remains inside the plumbing or construction.

- Making the diameter of the pipe smaller, elongating the length or leaving the object inside the pipe incidentally leads to excessive pressure on the pump, and this may cause a shortened life duration of the diaphragm, as the temperature of the pump increases significantly.

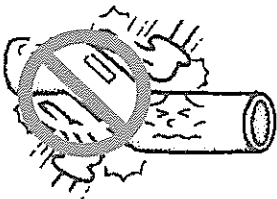

- Connect the pump and the pneumatic piping with the attached L-shaped hose and firmly attach with a hose clamp.
- Adjust the outlet of the pump and the position of the pneumatic piping to avoid unreasonable pressure to the L-shaped hose.

- When using the pump to inject air into water, make sure that the pump is higher than the surface level of the water, otherwise that water may run back into the pump if the power is interrupted. The pump should be in an upright, level position and remain on a stable, rigid operating surface for proper operation.

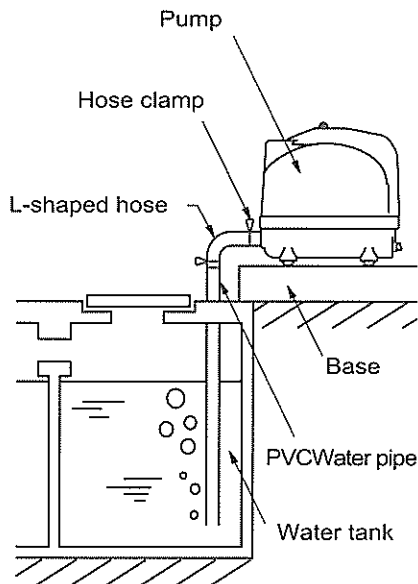

The pump has to be located at a place where accidentally fall into water could not happen.

- Confirm whether air is breathed out after installation.

6. Preliminary cautions

⚠ Warning

- Do not break or modify the power cord.
 - This may cause electrocution or fire.
 - Do not heat the object, pull the object or place things on top of the object, as this may cause damage.

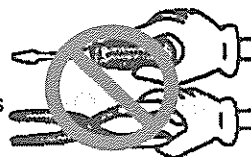

- Check at least once a year to make sure the plug is not dusty, and fully insert the plug into the socket.
 - A dusty or incompletely connected plug may cause electrocution or fire.



⚠ Caution

- Do not touch the plug with wet hands.
 - This will cause electrocution.



- Hold the plug to unplug the power cord.
 - Holding the cable to unplug may cause heat and ignition, resulting in the disconnection of part of the core wire.



- Do not wash the pump with water.
 - This may cause electrical leakage, electrocution and/or short-circuit accidents.



2 Daily Maintenance

This is for the maintenance by the user.

But please contact the service person in case of any problem.

⚠ Caution

- Before cleaning, unplug the power cord to cease operation and be sure the machine is completely cooled down.
- Foreign objects and/or dust in the pump may cause electrical leakage, short-circuit accidents and burn injuries.

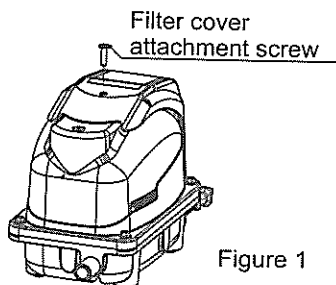
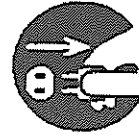

Figure 1

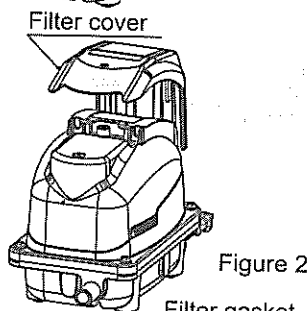

Figure 2

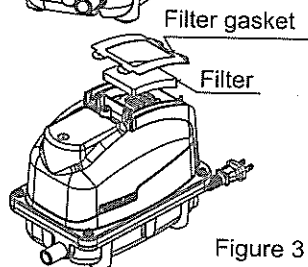

Figure 3

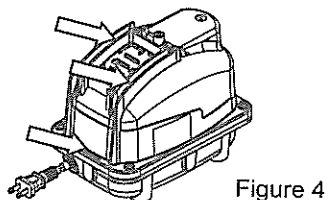

Figure 4

① Unplug the power before working.

② Remove the filter cover attachment screw. (Figure 1)

⇒ If the screw head is sandy or dusty, the chase will be ruined.

Remove the sand and dust first, then remove the screw.

Be careful not to drop or lose the screw.

③ Remove the filter cover. (Figure 2) Hold both ends and pull upward.

⇒ Be careful when removing the filter cover, as foreign objects or dust may fall.

Comparatively heavy sand dust will not fall to the filter, but it will fall on the rear housing.

④ Remove the filter from the upper housing and replace it with a new or clean one. (Figure 3)

Flick the dirty filter well to remove the dust. When it is extremely dirty, use neutral detergent and rinse well, then let dry in the shade.

⑤ Check and make sure the air inlet is not clogged.

⑥ Remove the dust at the Upper housing rear. (Figure 4)

⑦ The filter is attached and the filter gasket is attached. When the filter gasket comes off, make sure all four projections of the gasket are attached in the holes on the upper housing, then set the filter cover. (Figure 5)

If the filter gasket is not attached properly, the filter will not be in the correct position and it will be difficult to collect dust effectively. Moreover, rainwater may come inside.

The holes of the Filter gasket shall be attached in the projections on upper housing.

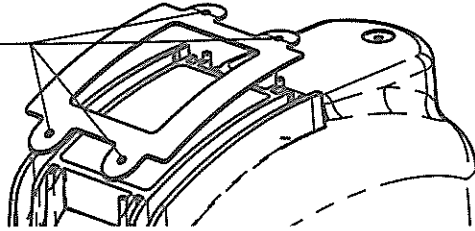

Figure 5

Caution

- Do not lift up the pump while holding the Filter cover.
Filter cover may be damaged or injuries may be incurred by falling pump.

Daily check items

- Proper air flow.
- Unusual sounds or vibrations from the pump.
- Pump temperature is too high.
- Defects or discoloration on the power cord and plug.
- ※ Refer to [3·1 Request to repair] when something is wrong.

3 After-service care (For service person use only)

3·1 Request to repair

- If machine is not working properly, please double check the following items.

Problem	Point to be checked
<input checked="" type="radio"/> Pump does not work	<input checked="" type="radio"/> Is there a blackout? <input checked="" type="radio"/> Is it unplugged?
<input checked="" type="radio"/> Air volume decrease <input checked="" type="radio"/> Extremely high temperature <input checked="" type="radio"/> Pump sometimes stops working	<input checked="" type="radio"/> Is the air inlet, plumbing or aeration tube clogged? <input checked="" type="radio"/> Is the plumbing valve clogged? <input checked="" type="radio"/> Is the filter or air inlet clogged?
<input checked="" type="radio"/> Makes unusual sounds	<input checked="" type="radio"/> Is it coming into direct contact with surrounding objects?

- After inspecting the above points, if there is still a problem, unplug to cease operations and contact the distributor or the maintenance shop.

Name of product : HIBLOW Air Pump

Model type : XP-40 XP-60 XP-80

Failure report (as closely as possible in detail)

Warning

- Do not keep continue operation with machine in questionable condition.
 - This may cause breakdown, electrical leakage, electrocution and/or short-circuit accidents.
- Do not repair the pump yourself.
 - Imperfect repair causes electrical leakage, electrocution and/or short-circuit accidents.

Should you have any questions regarding after-service care, please contact the distributor, maintenance shop or customer service of our company.

3·2 Repair Parts (Do not repair the pump by yourself)

Use our brand-name parts for repair.

Using other brand parts causes damage, as the sizes are different.



Head office,

8-16 Hacho-Nishimachi, Takatsuki-shi, Osaka, 569-0095, Japan. TEL +81.72.684.0805 FAX +81.72.684.0807

Manual

Refer to the website other languages.

https://www.hiblow-jp.com/hiblow_manual/

Bedienungsanleitung

Ausgaben in anderen Sprachen finden Sie auf der Website.

https://www.hiblow-jp.com/hiblow_manual/

Manuel

Consultez le site internet pour d' autres langues.

https://www.hiblow-jp.com/hiblow_manual/

Manuale

Fare riferimento al sito web per le altre lingue.

https://www.hiblow-jp.com/hiblow_manual/

Manual

Consulte el resto de idiomas en el sitio web.

https://www.hiblow-jp.com/hiblow_manual/

Руководство

Версии на разных языках можно скачать по ссылке

https://www.hiblow-jp.com/hiblow_manual/

Instrukcja obsługi

Inne wersje językowe dostępne na stronie internetowej.

https://www.hiblow-jp.com/hiblow_manual/

Návod

Viz ostatní jazyky webové stránky.

https://www.hiblow-jp.com/hiblow_manual/

Návod

Ostatné jazyky nájdete uvedené na webovej stránke.

https://www.hiblow-jp.com/hiblow_manual/

Vadovas

Vadovą kitomis kalbomis galite rasti

https://www.hiblow-jp.com/hiblow_manual/

Manual

Consulte o website em outras línguas.

https://www.hiblow-jp.com/hiblow_manual/